









































PLATON SERVICE
8 (800) 500-34-41
www.platonservice.com

MIRRA 220 AI C AF CE

	REF	ART	COD
	02	BASE/FRAME FOR SLICER MIRRA 220-250	19510101/01
	04	FUSS M5 FUER AUFSCH. 	19560201
	06	INT.LAMA 220 MRR DAL 09 OSSIDATO	19510248.09
	12	FLATHEAD CSK SCREW DIN 963 M5 X 14	IX2963005014
	14B	ESAGONO INTERNO LAMA 220 MRR-SMR	19530910
	14A	LOCK NUT CNV (MRR)	19530901.10
	15	RIM GUARD PIN_MRR 220-300/PLD 350	19534081
	16	MESSER 220-40/3/180 CE	18220403180F
	16T	BLADE 220 - 40/3/180 CE TEFLON	18220403180TF
	18	BLADE RIM GUARD 220 MRR	19513001/01
	20	SCREW POELIERS M 5X12	IX2POEL005012
	22A	LAGERWELLE FUER MIRRA 220-300	19700332
	22B	PULEG.PRES.MONT.MRR."AF"220-300 Y10	19700340AF.10
	24	RIEME TB2 345X8 Aufschn.	19310201
	28	MICROSWITCH HOLDING RING _ MIRRA	19540901
	30	GRUB SCREW DIN 916 M 6X8 NE	NE0916006008
	32	SCHRAUBE/BOLZEN FUER MIRRA	19530532
	34B	TIE ROD KNOB M 6 BLUE _ MIRRA	19564016
	34A	TIE ROD KNOB M6X5 FOR MIRRA	19562502
	36	PARAFETTA ACCIAIO MRR 220 NEW	19531001
	38	DEFLECTOR SCREW M5 _ MIRRA	19335014
	40	VELA MRR 220 STAMP.CE DAL 09 OSS.	195103E01C.09
	48	KUNSTSTOFFABDECKUNG _ MIRRA 220-300	19560132
	52	HEX.NUT DIN 934 M 6	IX2934006

PLATON SERVICE
 (800) 500-3447
 www.platonservice.com

	54	FIXING SCREW_MIRRA 220-250	19335060
	56	WASHER LARGE DIN 9021 D 6X18	IX29021006018
	58	THICK.PLATE SUPPORT_MIRRA 220-250 C	19510701/01
	62	LARGE WASHER	19563002
	64	THICKNESS PLATE SLIDE _ MIRRA	19500101/01
	65	MOVEMENT HEAD D8,5XHT2 FOR SLICER	19563201
	66	SLIDE GUIDE _ MIRRA	19540601
	68	GRUB SCREW DIN 916 M 6X10 NE	NE0916006010
	70	HEX.SCREW DIN 933 M5 X 12	IX2933005012
	74	SPRING PIN _ MIRRA 220/50	19531360
	78	SLIDE SPRING _ MIRRA 220-250	19390201/02
	80	PLATE SLIDE PIN D12X122,5 _ MIRRA	19530701
	82	BRASS STUD BOLT M6 X 17 _ MIRRA	19337032
	84	HEX.NUT DIN 934 M 6	IX2934006
	86	FLAT WASHER DIN 125 D 6	IX2125006
	88	LOW HEX.NUT DIN 439 M 6	IX2439006
	90	CAM PIN FOR MIRRA	19336062/01
	92	CAM FOR MIRRA 220/275/300	19563505LG
	95	PLASTIC WASHER FOR CAM_MIRRA	19563275
	96	CORRUGATED WASHER 12	19342005
	98	SCRAUBE DIN 916 M 5X6 NE	NE0916005006
	100	THICKNESS KNOB WASHER _ MIRRA	19562145
	102B	THICKNESS KNOB BLUE_MIRRA	19564020
	102A	MANOPOLA NUMERATA MRR C	19562403
	106	HOLDING RING NUT _ MIRRA 250	19534062
	108	FLAT WASHER DIN 125 D 8	IX2125008
	110	HEX.NUT DIN 934 M8	IX2934008
	120	MESSERABZIEHER FUER AUFSCHN.220	19702502

Ver. Fino al 06/2006
Ver. Until 06/2006

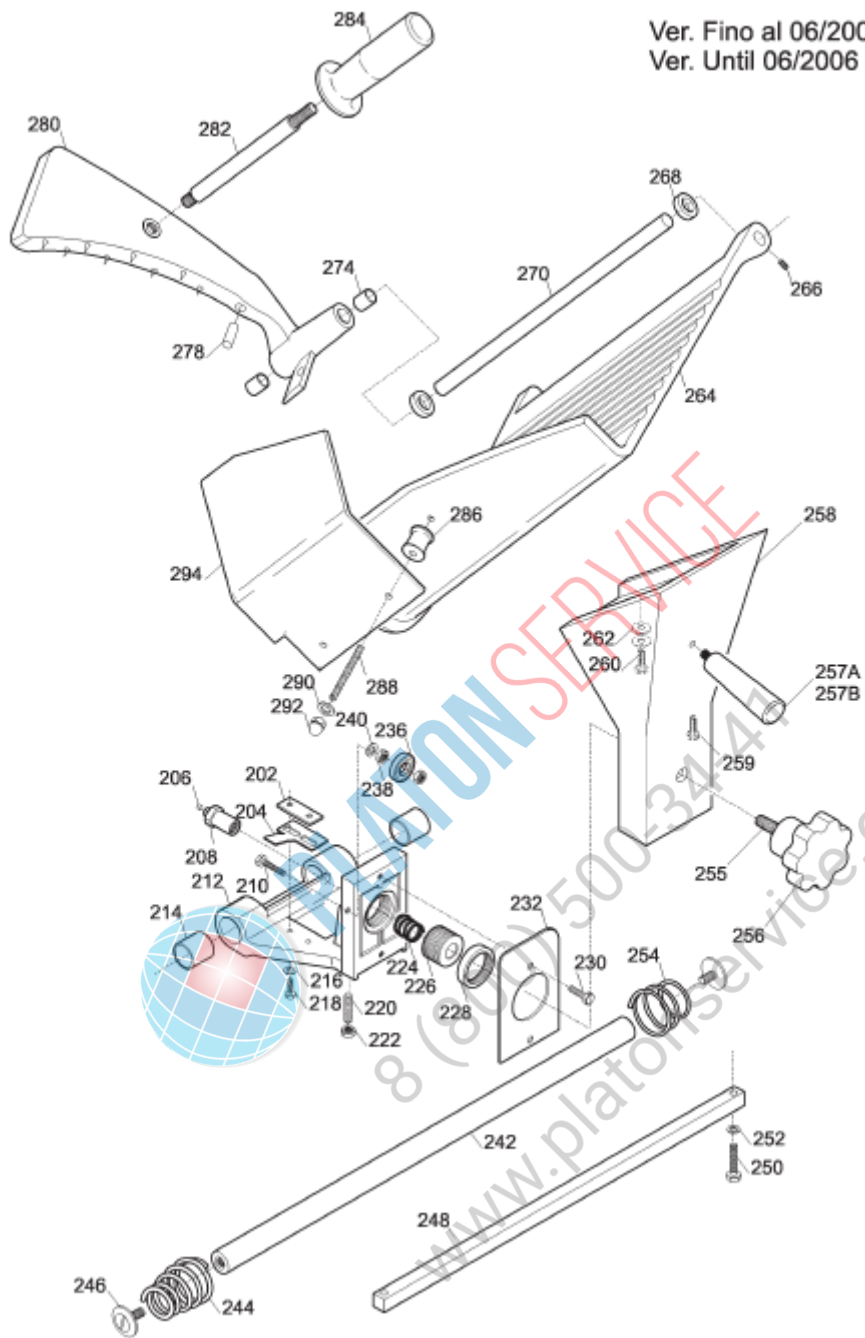

MIRRA 220 AI C AF CE

	REF	ART	COD
	202	THREADED RELEASE PLATE _ SLICER CE	19533200
	204	CARRIAGE RELEASE PLATE _ MIRRA CE	19533210
	206	DRUCKSTUECK ABWURF 300/385 CE	19565001
	208	PIN _ SLICER 220-250 CE	19534034
	210	SCREW TE DIN 933 M 6X30 T.F.	IX2933006030
	212	CARRIAGE FOR SLICER	19500516
	214	BUSHING 18.20.20	19324108
	216	FLAT WASHER DIN 125 D 6	IX2125006
	218	SCREW TE DIN 933 M 6X22 T.F.	IX2933006022
	222	HEX.NUT DIN 934 M 6	IX2934006
	224	RELEASE SPRING 220-250 CE	19390600
	226	BUCHSE	19534024
	228	LOCKRING EXT._ SLICER 220-250 CE	19534029
	230	HEX.SCREW DIN 933 M5 X 10	IX2933005010
	232	PIASTRINA CARRELLO 220-250-300V CE	19533001
	234	LOW HEX.NUT DIN 439 M 6	IX2439006
	236	CARRIAGE BEARING 626 2RS R50_MIRRA	19320103
	238	HEX.NUT DIN 934 M 6	IX2934006
	240	FLAT WASHER DIN 125 D 6	IX2125006
	242	SLIDE ROUND BAR _ MIRRA	19530601
	244	ROUND BAR SPRING D.18 MIRRA 220-250	19390111
	246	ROUND BAR SCREW T.20_MIRRA	19335001
	248	SQUARE BAR _ MIRRA	19540101
	250	HEX.SCREW DIN 933 M5 X 20	IX2933005020

PLATON SERVICE
8 (800) 500 3441
www.platonservice.com

MIRRA 220 AI C AF CE

	REF	ART	COD
	254	ROUND BAR SPRING MIRRA220-250	19390101
	255	VITE SENZA TESTA DIN 913 M 8X30 CE	IX2913008030
	256	HEX.NUT DIN 934 M 6	IX2934006
	256B	BLADE GUARD TIE ROD KNOB M8 _ BLUE	19564013
	256A	GRIFF MESSERSCHUTZ SCHRAUBE	19562504
	257B	MEAT PRESS HANDLE, BLUE _ MIRRA	19564019
	257A	KNOB FOR MEAT PRESS/CARRIAGE	19562901
	258	GAMBO MRR CE OSSIDATO	19510616
	260	SCREW TE DIN 933 M 6X22 T.F.	IX2933006022
	262	WASHER LARGE DIN 9021 D 6X18	IX29021006018
	264	PRODUCT PLATE MIRRA 250 C 4 HOLES	195104011
	266	SCRAUBE DIN 916 M 5X6 NE	NE0916005006
	268	ABSTANDSSTÜCK MRR. D21X12MM	19561520
	274	BUSHING 10.12.10	19324101
	278	BUFFER D6,5X30 FOR MIRRA	19563208
	280	MEAT PRESS FOR SLICER	195109020
	281	WASHER DIN 125 D 10	IX2125010
	282	DISTANZRING D12X150 MIRRA CE PRO	19541508
	284B	MEAT PRESS HANDLE - BLUE	19564012
	284A	KNOPF FUER RESTEHALTER AUFSCH.CE	★ 19562904
	286	DISTANZRING D.20X15MM	19521601
	288	STUD BOLT M5 X 30	19336003
	290	WASHER LARGE DIN 9021 D 5X20	IX29021005020
	292	BLIND NUT DIN 1587 M5	IX21587LC005
	294	HANDSCHUTZ FUER MIR/PRL/TOP 220-250	★ 19562322

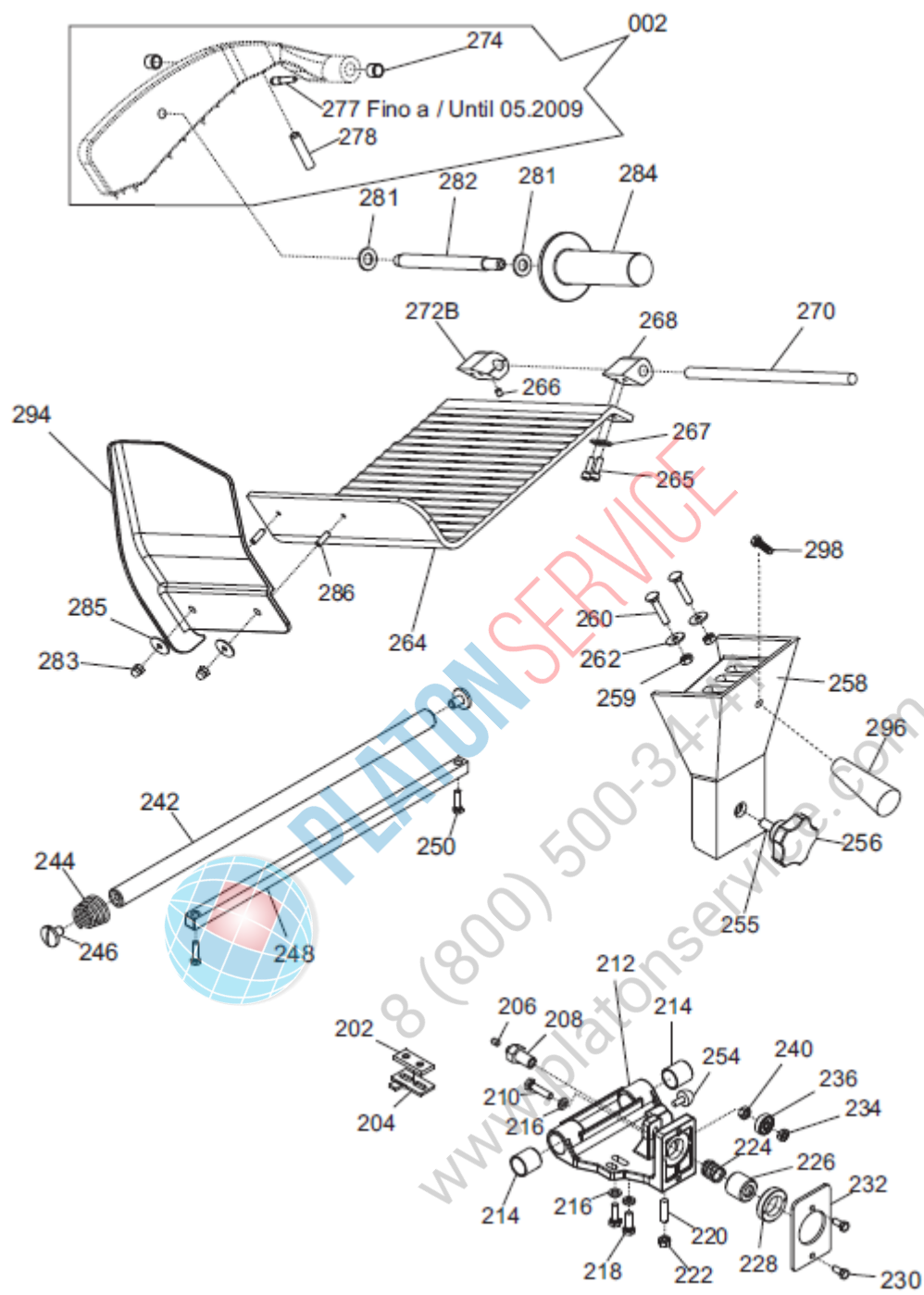

MIRRA 220 AI C AF CE

	REF	ART	COD
	002	MEAT PRESS ASSEMBLY MIRRA-CANOVA CE	19801233
	202	THREADED RELEASE PLATE _ SLICER CE	19533200
	204	CARRIAGE RELEASE PLATE _ MIRRA CE	19533210
	206	DRUCKSTUECK ABWURF 300/385 CE	19565001
	208	PIN _ SLICER 220-250 CE	19534034
	210	SCREW TE DIN 933 M 6X30 T.F.	IX2933006030
	212	CARRIAGE FOR SLICER	19500516
	214	BUSHING 18.20.20	19324108
	216	FLAT WASHER DIN 125 D 6	IX2125006
	218	SCREW TE DIN 933 M 6X22 T.F.	IX2933006022
	220	BRASS STUD BOLT 6X25	19337002
	222	HEX.NUT DIN 934 M 6	IX2934006
	224	RELEASE SPRING 220-250 CE	19390600
	226	BUCHSE	19534024
	228	LOCKRING EXT_ SLICER 220-250 CE	19534029
	230	HEX.SCREW DIN 933 M5 X 10	IX2933005010
	232	PIASTRINA CARRELLO 220-250-300V CE	19533001
	234	LOW HEX.NUT DIN 439 M 6	IX2439006
	236	CARRIAGE BEARING 626 2RS R50_MIRRA	19320103
	238	HEX.NUT DIN 934 M 6	IX2934006
	240	HEX.NUT DIN 934 M 6	IX2934006
	242	SLIDE ROUND BAR _ MIRRA	19530601
	244	ROUND BAR SPRING D.18 MIRRA 220-250	19390111
	246	ROUND BAR SCREW T.20_MIRRA	19335001



 (800) 500-3441

www.platonservice.com

MIRRA 220 AI C AF CE

	REF	ART	COD
	248	SQUARE BAR _ MIRRA	19540101
	250	HEX.SCREW DIN 933 M5 X 20	IX2933005020
	254	CARRIAGE BUFFER M5X12 MIRRA 220-300	19560170
	255	VITE SENZA TESTA DIN 913 M 8X30 CE	IX2913008030
	256B	BLADE GUARD TIE ROD KNOB M8 _ BLUE	19564013
	256A	GRIFF MESSERSCHUTZ SCHRAUBE	19562504
	258	GAMBO MRR CE OSSIDATO	19510616
	259	HEX.NUT DIN 934 M 6	IX2934006
	260	SCREW, PRODUCT PLATE MIRRA 220-250	19335042
	262	WASHER LARGE DIN 9021 D 6X18	IX29021006018
	264	PIATTO MRR CE 220 EST. OSS.	195104E013
	265	HEX.SOCKET HEAD CAP SCREW M5 X 16	IX2912005016
	266	SCRAUBE DIN 916 M 5X6 NE	NE0916005006
	267	GROWER WASHER UNI 1751 D.6	IX21751006
	268	ROD BLOCK, STRAIGHT _ MIRRA Y06	19525062
	270	MEAT PRESS ROD_MRR 250 Y06/CANOVA25	19530402.06
	272B	ROD BLOCK, INCLINED _MIRRA Y10	19525060.10
	274	BUSHING 10.12.10	19324101
	277	MEAT PRESS INSERT	19563213
	278	MEAT PRESS BUFFER D8,5XH36	19563206
	281	WASHER DIN 125 D 10	IX2125010
	282	DISTANZRING D12X150 MIRRA CE PRO	19541508
	283	BLIND NUT DIN 1587 M5	IX21587LC005
	284B	MEAT PRESS HANDLE - BLUE	19564012
	284A	KNOPF FUER RESTEHALTER AUFSCH.CE	19562904
	285	WASHER LARGE DIN 9021 D 5X20	IX29021005020
	286	GRUB SCREW DIN 913 M 5X16 CE	IX2913005016
	294	HANDSCHUTZ/PLEXIGLAS MIRRA 220-250	19562322.06
	296B	MEAT PRESS HANDLE BLUE _ MIRRA	19564019.13
	296A	KNOB FOR MEAT PRESS/CARRIAGE	19562901
	298	VITE TE DIN 933 M 6X18 T.F.	IX2933006018

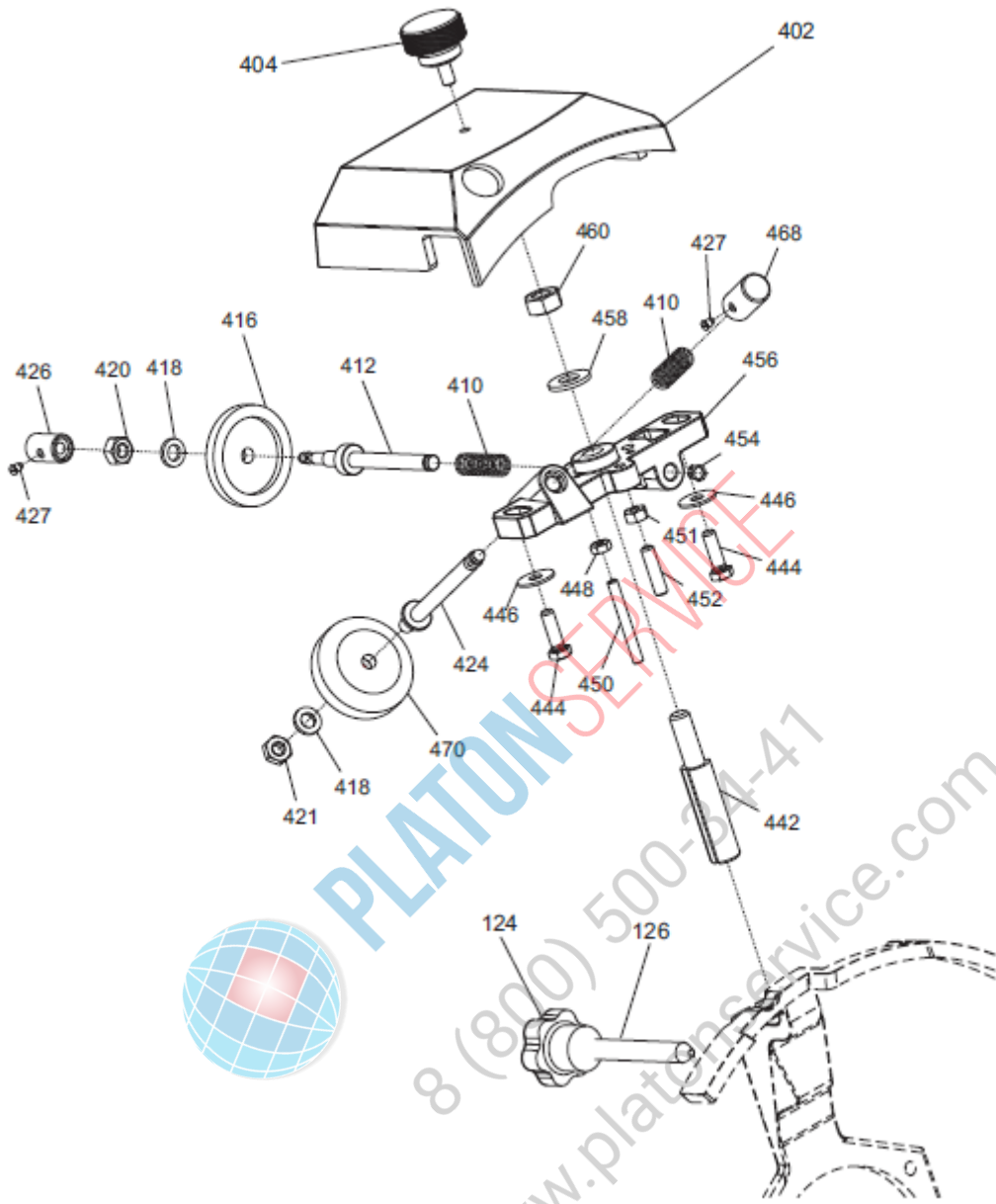





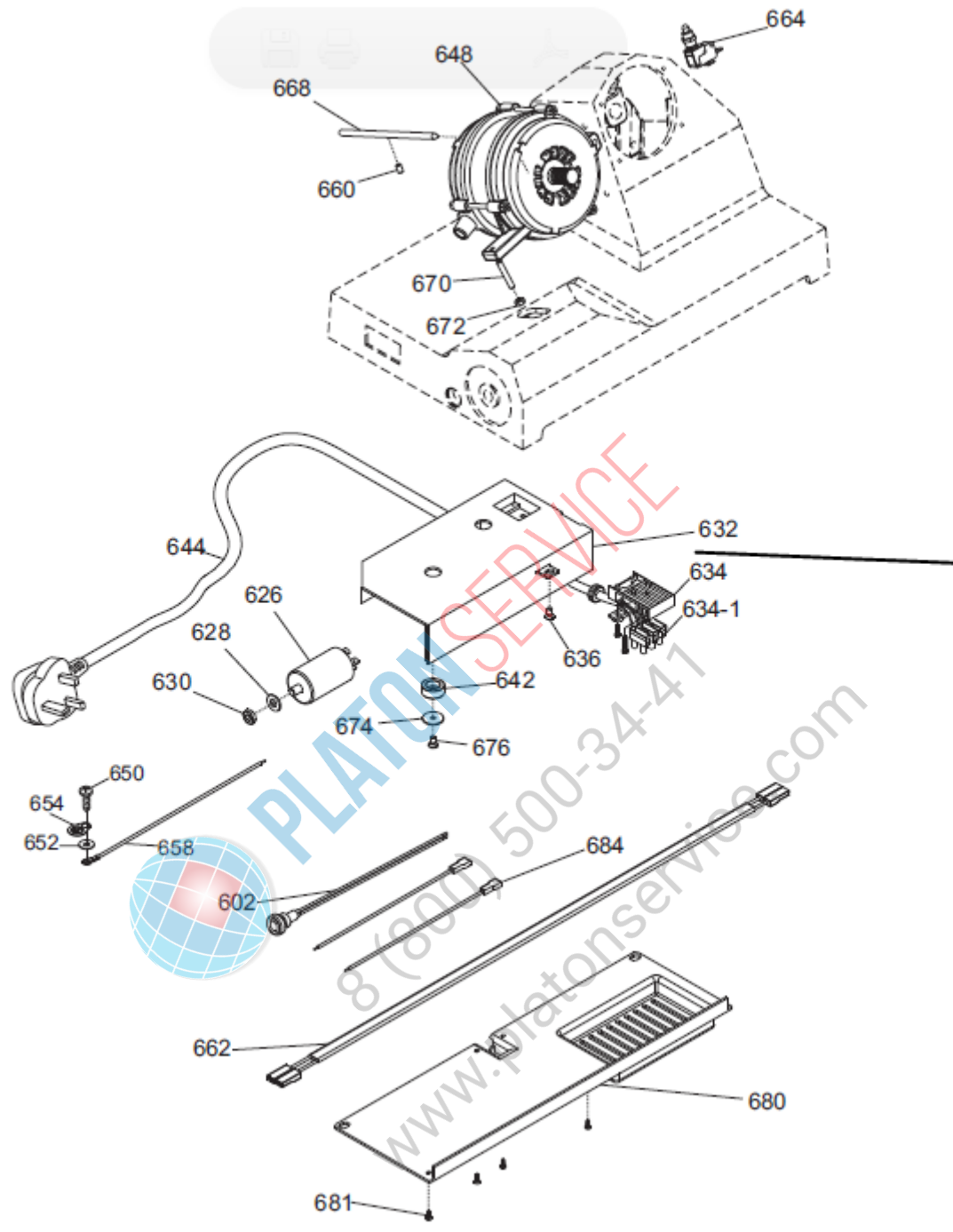























MIRRA 220 AI C AF CE

	REF	ART	COD
	-	AFFILAT.INC.CE MRR C 250G-300 VERT	19800032
	124A	FESTSTELLSCHRAUBE FUER AUFSCH.	19562602
	124B	BLUE KNOB M8	19564015
	126	KNEBEL FUER AUFSCH.	19336010
	402	CAPP.MRR 220-250G 300SV CE OSSIDATA	19511202C
	404A	HANDGRIFF TW	19562701
	404B	KNOB M 5 BLUE	19564018
	410	SHARPENER SPRING _ SLICER 250-300	19390303
	412	DEBURRING PIN _ SLICER 250-300	19540703
	416	SCHLEIFSTEIN D.40 H.8 F.6 AUFSCHN	19300201
	418	FLAT WASHER DIN 125 D 6	IX2125006
	420	HEX.NUT DIN 934 M 6	IX2934006
	421	LOW HEX.NUT DIN 439 M 6	IX2439006
	424	SHARPENING PIN _ SLICER 250-300	19540704
	426	DEBURRING BUTTON _ SLICER 250-300	19550203
	427	BUTTON LOCKING SCREW _ SLICER 250-370	19335025
	442	PERNO COL.FR.MRR.250G/300V L=62,5	19540432
	444	HEX.SCREW DIN 933 M5 X 16	IX2933005016
	446	WASHER LARGE DIN 9021 D 5X15	IX29021005015
	448	HEX.NUT DIN 934 M 4	IX2934004
	450	GRUB SCREW DIN 913 M4 X 35 CE	IX2913004035
	451	HEX.NUT DIN 934 M 5	IX2934005
	452	GRUB SCREW DIN 913 M5 X 20 CE	IX2913005020
	454	SEEGER DIN 471 D 06E	IX2471006
	456	SHARPENER FRAME _ MIRRA VERT.220-300	19021332
	458	FLAT WASHER DIN 125 D 8	IX2125008
	460	HEX.NUT DIN 934 M8	IX2934008
	468	SHARPENING BUTTON _ SLICER 250-300	19550202
	470	SCHLEIFSTEIN D.40 H.11 F.6 AUFSCHN	19300101



MIRRA 220 AI C AF CE

	REF	ART	COD
	600	EIN/AUSSCHALTER 230 V FUER AUFSCH. 	19410152
	602	KONTROLLAMPE 220-380 V	19410406
	626	KONDENSATOR 8 uF _ MIRRA/QUARZO	19410301
	628	FLAT WASHER DIN 125 D 8	IX2125008
	630	LOW HEX.NUT DIN 439 M8	IX2439008
	632	RELAY HOUSING 11-04-97 _ MIRRA	19563125
	634-1	TERMINAL BLOCK 3 POLES 27	19410822
	634	SUB-TERMINAL PA 228	19410820
	636	SCREW TC-DIN 84 M 5X10	IX284005010
	642	HOUSING SPACER RING	19561500
	644	UK POWER CORD SINGLE PHASE	19410504
	648	MOTOR 230/50 P.40 _ MIRRA	19403042
	650	VITE AUTOF.TCB+ DIN 7981 D 3,5X9,5	IX279813,5009,5
	652	WASHER DIN 6798-A D 4E	IX26798A004
	654	GROUND LABEL	19420177
	658	GROUND CABLE UL _ MIRRA 220-250	19410738
	660	SCRAUBE DIN 916 M 5X6 NE	NE0916005006
	662	CAVO MICRO 220-250 AF/BULTH	194107013
	664	ENDSCHALTER FUER AUFSCNITTMASCHINE	19410201
	668	S/S MOTOR ROD _ MIRRA	19540501
	670	GRUB SCREW DIN 913 M 5X30 CE	IX2913005030
	672	HEX.NUT DIN 934 M 5	IX2934005
	674	WASHER LARGE DIN 9021 D 5X20	IX29021005020
	676	SCREW TC-DIN 84 M 5X10	IX284005010
	680	BOTTOM COVER _ MIRRA 220-250	19563151
	681	SELF-TAP.CONVEX HEAD SCREW D2,9X9,5	IX279812,9009,5
	684	INDICATOR LIGHT CABLE	19410750